



FARM & COMMERCIAL SLIDING DOOR SYSTEMS



PRODUCT CATALOG 2020



WeatherGuard™ protection greatly enhances the performance of standard zinc products, formulated to withstand the harshest weather conditions and stand up to the corrosive effects of pressure treated lumber. Extensive testing and field use have proven WeatherGuard is far superior in corrosion resistance over competitive standard zinc-plated products.

When subjected to 312 hours of salt fog spray testing (BHMA A156.18), standard zinc hardware showed severe corrosion while hardware protected by WeatherGuard withstood these harsh conditions with very little deterioration.

Benefits of WeatherGuard™:

- Superior corrosion protection for indoor & outdoor use
- Extends the life and aesthetics of steel hardware products
- Safe for use with pressure treated/ACQ lumber

For more information about WeatherGuard™ visit:
www.nationalweatherguard.com

TABLE OF CONTENTS

SLIDING DOOR APPLICATIONS

Typical Installations	5
Single	7
By-Passing	7
Accordion Fold	7
Planning Checklist	8

SLIDING DOOR FRAMES

Tab-Loc™	9-11
Easy-Frame®	12-13
Sliding Door Frame Accessories	14-16
Max Easy-Frame	17-19
Sliding Door Frame Accessories	20

BOX RAILS

Box Rail & Accessories	21-24
Box Hangers	25
Flexible Box Hangers	26
Rigid Box Hangers	27
Installations/Rails-Hanger Chart	28

TRACKMASTER® ROUND RAIL & HANGERS

Round Rail & Accessories	29-35
Benefits	30
Checklist	31
Round Rail & Brackets	32
Flashing	33
Round Hangers	34-35



SLIDING DOOR APPLICATIONS



Aircraft Hanger



Horse Facility



Lumberyard



Livestock Facility

TYPICAL INSTALLATIONS

All Wood Frame Sliding Door

1-1/2" or 3-1/2" Thick With Metal Siding on Metal Sided Building

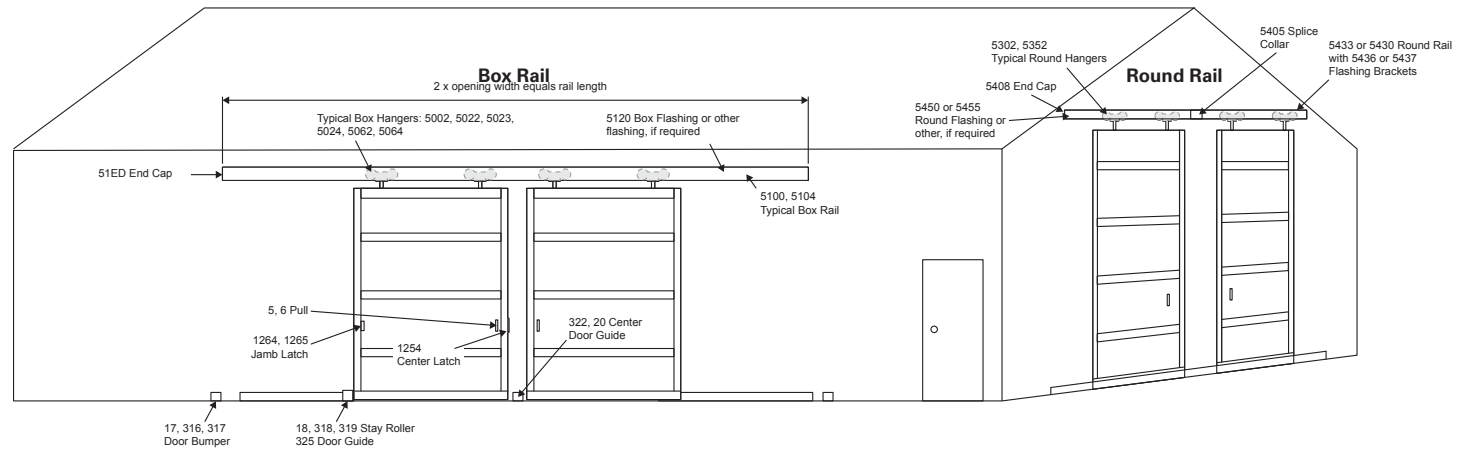

All Wood Frame Sliding Doors (Less Than 1-1/2" Thick Frame)

Less Than 1-1/2" Thick Frame With Wood Siding on Wood Sided Building

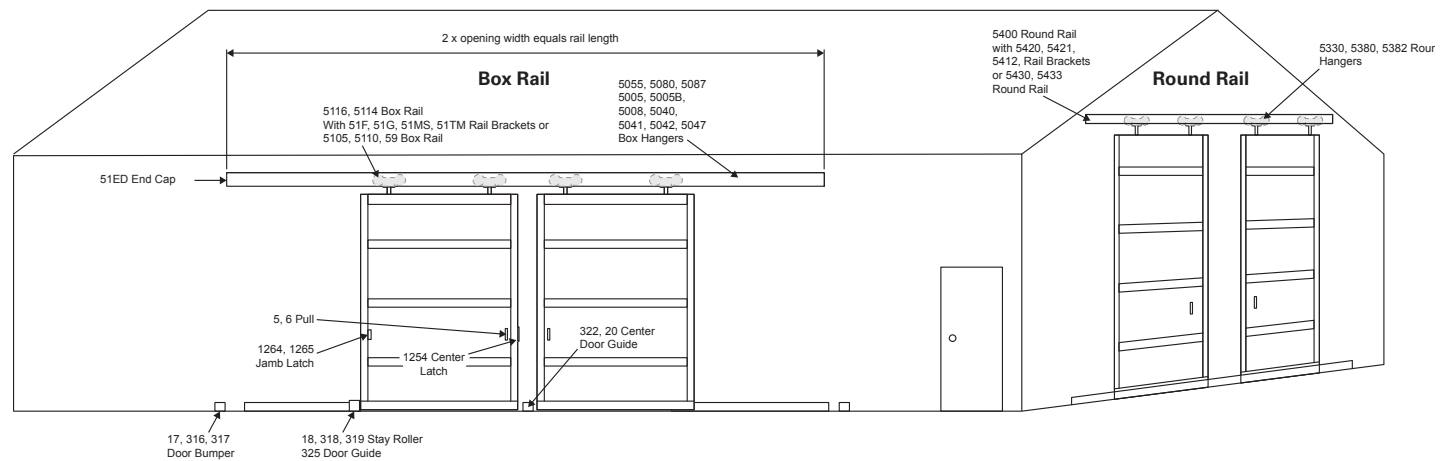

TYPICAL INSTALLATIONS

Single & Bi-Parting for Box & Round Rail

Operation: A single sliding door, or two sliding doors meeting at the center of the opening (bi-parting) allowing maximum doorway access to the building. This system requires a single run of rail approximately twice the width of the door opening running along the door side of the building to carry the door(s).

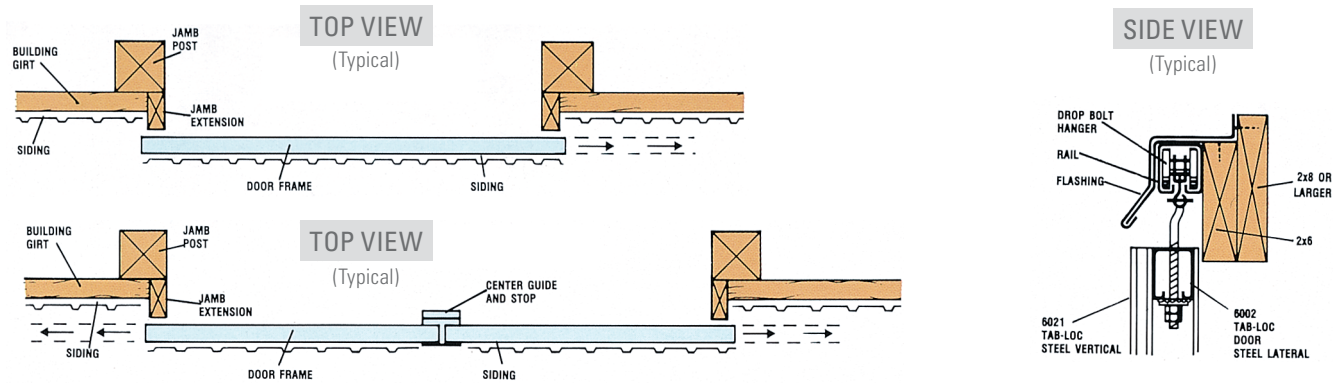

By-Passing for Box & Round Rail

Operation: Two runs of rail carry two or more door panels. When open, the inner panel(s) store behind the outer panel(s). Triple brackets are also available for triple runs of rail.

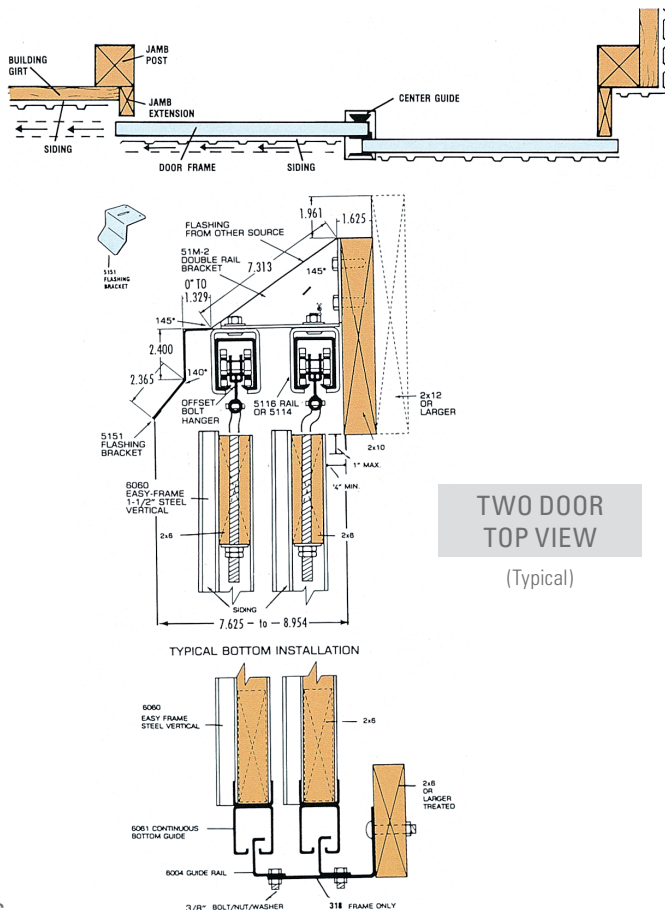

Accordion

The Accordion system is used in churches, schools and auditoriums or wherever a number of doors are hung together in series in an opening. No. 47 hangers and 5116 or 5114 rail are used. The system can be suspended from the header with ceiling brackets, or the rail may be secured with tech screws drilled directly to the header.

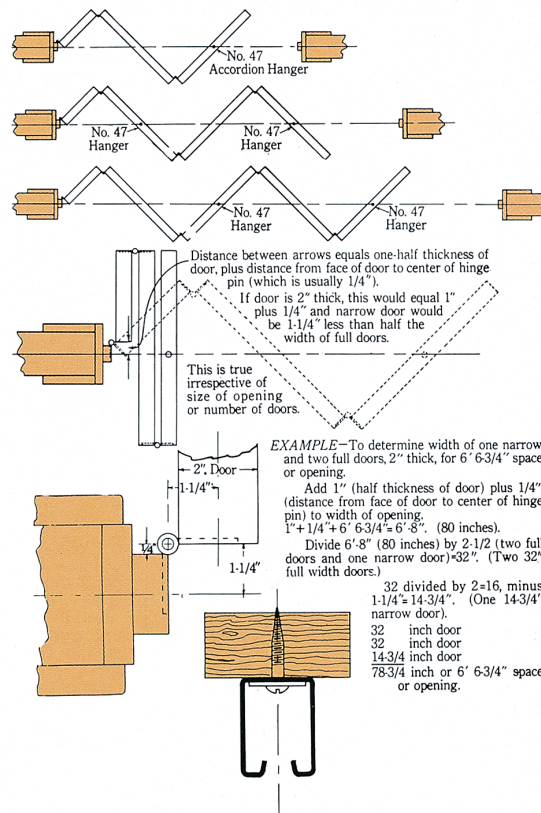

SLIDING DOOR SYSTEMS PLANNER

Single & Bi-Parting

- Box or Round Rail
- Rail Brackets (if needed)
- Rail Flashing (if needed)
- Hangers
- Door Bumpers/Stops
- Door Guides
 - Floor Mounted
 - Side Mounted
- Stay Rollers
- Jamb Latches
- Center Latch
- Door Pulls
- Door Frame Systems
 - Easy-Frame®

By-Passing

- Box or Round Rail
- Double or Triple Rail Brackets
- 5151 Flashing Brackets
- Hangers
- Door Bumpers
- Door Guides
 - Floor Mounted
 - Side Mounted
- Stay Rollers
- Jamb Latches
- Center Latch
- Door Pulls
- Door Frame Systems
 - Easy-Frame®

Accordion/Fold

- 5116 Box Rail
- Box Rail Brackets
- 47 Accordion Hangers
- Door Guides
- 835-24" Cane Bolt
- 512 or 129 Hinges
- Door Pulls
- Center Latch
- Door Frame Systems
 - Easy-Frame®

SLIDING DOOR FRAMES - EASY FRAME®

Easy Frame® Steel & Wood Frame

for 1 1/2" and 3 1/2" wood laterals for Box and Round Rail Systems

Materials Checklist

1. Rail cover
2. Rail
3. Hanger
4. Wood lateral (top) (2" x 6")
5. Pre-finished steel vertical
6. Wood lateral (bottom) (2" x 6")
7. Door covering/siding
8. Continuous bottom guide rail
9. Guide rail bracket
10. Guide rail
11. Center guide & stop (for bi-parting doors)*
 - 11a. Center guide (for larger, single doors)*
12. Door stop (bottom mount)*
 - 12a. Door stop (jamb mount)*
13. Jamb latch*
 - 13a. Center door latch (for bi-parting doors)*
14. Door pull*
15. Door astragal*

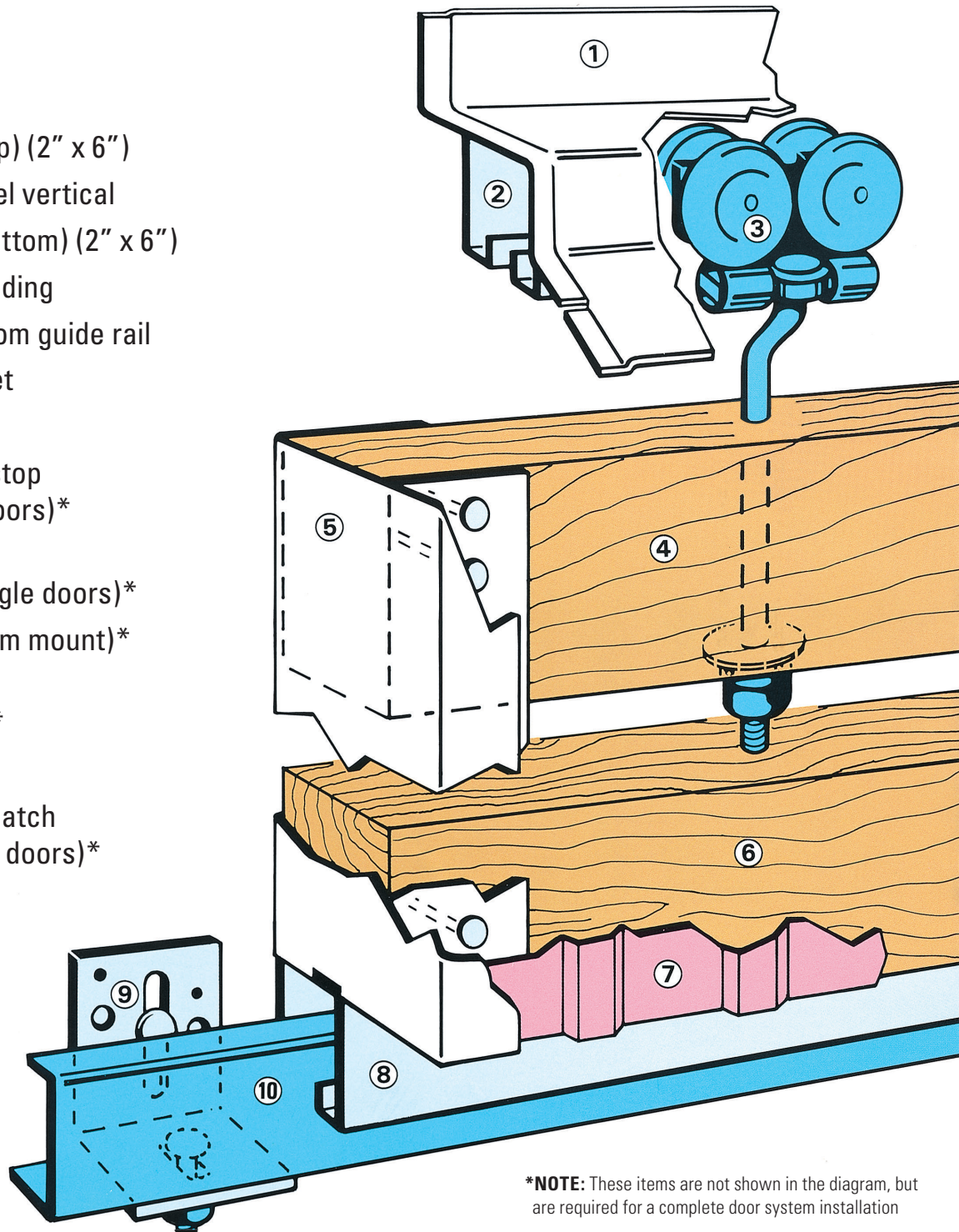

***NOTE:** These items are not shown in the diagram, but are required for a complete door system installation

SLIDING DOOR FRAMES - EASY FRAME®

1-1/2" Thick Door

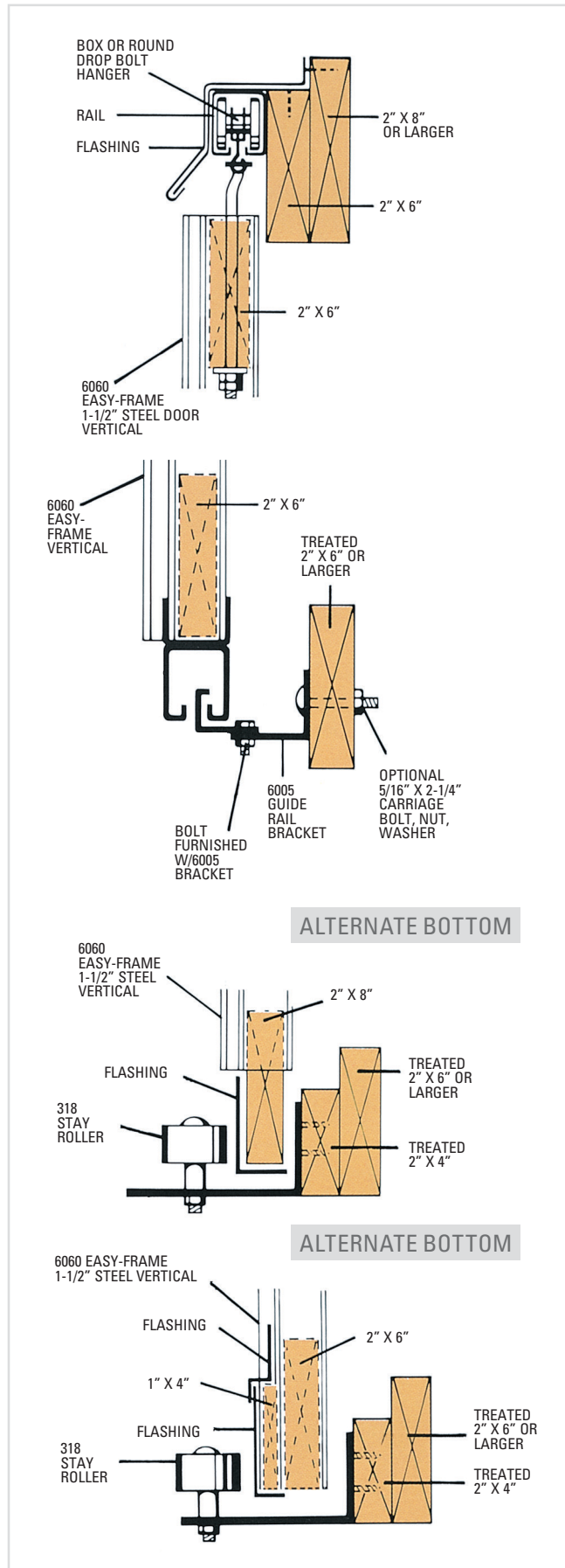

3-1/2" Thick Door

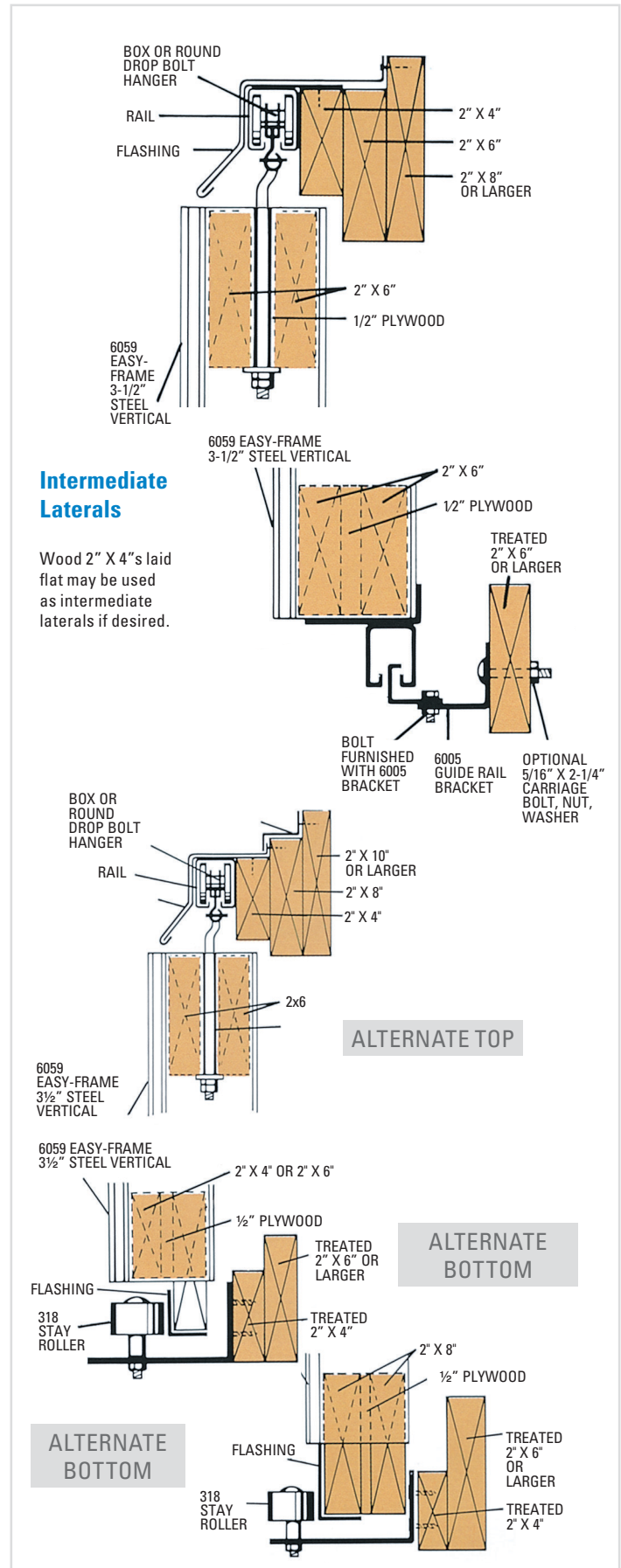

SLIDING DOOR FRAME ACCESSORIES

SLIDING DOOR FRAME ACCESSORIES

TAB-LOC™ & Easy Frame® Accessories



6005 Guide Rail Bracket—For use with No. 6004 Guide Rail. Slotted hole in each leg allows both lateral and vertical adjustments. Bolts, nuts and washers included.



1254 Center Door Latch—Cam-action, adjustable hook holds bi-parting doors tight. For wood doors 1½" or thicker.

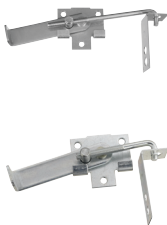

1264/1265 Jamb Latches—A cam-action latch designed to hold wood or metal sliding doors firmly in place against the door jamb. Also used on end gates, stake panels on trucks and other closures on farm buildings. Adjustable 4 inch hook. For right or left-hand installation. Handle of No. 1265 Latch can be used as a stop when door is in fully open position—simply flip handle approximately 180 degrees. No. 1264 Latch with 7 inch hook suitable for use where a long reach is necessary because of jamb construction.



6060 1½" Door Verticals—Self-flashing verticals with powder coated white finish over galvanized 16-gauge steel. Pre-punched on 24" centers for attaching 1½" lateral members.

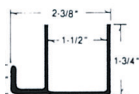

SLIDING DOOR FRAME ACCESSORIES

Additional Accessories

For a complete listing of all available hardware, see your retailer



316 Adjustable Door Bumper—Heavy-duty adjustable for single sliding or bi-parting door from 2½" to 3-1/8" thick.



20 Single Door Guide—Adjustable to maximum 3" door.



322 Door Guide—Heavy-duty center floor guide for bi-parting and single sliding metal or wood doors. Smooth ramp on each side prevents tire cutting. Mounts on concrete floors with lag screws and shields or on a 6"x 6" post. A ½" rod or bolt inserted through hole in each side serves as a center stop for bi-parting doors.



318 Stay Roller—For heavy-duty use. Slots in frame provide adjustment for holding sliding doors against wood walls or posts. Sturdy steel frame. Reversible. For doors up to 3-3/4" thick.



319—Heavy-Duty Stay Roller with Derlin® wheel and 3/8" x 4-1/2" lag screw with expansion shield. For doors of any thickness.



6 Door Pull—Extra heavy for variety of applications. White vinyl coated, zinc, galvanized or black. Length 6-3/4", width 1-3/8".



1134 Slide Bolt Latch—For doors and gates swinging in or out. Handle serves as pull. May be padlocked. Zinc plated, galvanized or satin black finishes.



1135 Latch—Sturdy, easy-operating, all purpose latch. Handle serves as a pull; latches right or left. The latch bar securely attached with two sets of guides and back plates, which provide a bearing surface for the bar and eliminate "grooving" of the wood as bar is moved back and forth. Extra strong bar strike has rounded edges. Ideal for horse barns and livestock enclosures.



1136 Stall and Gate Latch—Ideal for horse and other livestock stalls, residential or rural gates, doors, etc. Automatic retractable bolt clears entry. Rounded edges protects livestock. Right or left hand application. Zinc plated with weather proof finish.



25 Swinging Door Latch—Heavy-duty self-latching. Designed for installation on 3/4" to 2-1/4" thick doors. Bolt has rounded face to insure easy latching. Handle designed to prevent flattening when door swings back against building. Available for 3" door thickness. Available in zinc, black and stainless steel finish. Packed with hold-open catch.



835 24" Cane Bolt—Adjustable throw. Self-locking when mounted vertically.



20-2 By-passing Door Guide—Adjustable to maximum 3" door.



325 Door Guide—Extra wide guides ideal for corrugated metal-clad doors. Easy to install. Fasteners not furnished, but guides have holes for spikes as well as larger holes for 3/8" lag-screw mounting. Guide is adjustable for doors 5" x 5-1/2" thick. Curved section of guide may be turned sideways allowing straight access when installing screws.



18 Stay Roller—Embossed frame with two wings provide greater bracing and holding strength than conventional single-support, corner-iron frame. Derlin® wheel assures rust-free operation. Adjustable. For doors up to 2-1/4" thick.



13B Latch—Similar to No. 13 but furnished with extra strong bar strike with rounded edges. Sturdy one-half inch thick bar strike eliminates breakage. Can be padlocked. Cam action between handle and bar strike holds door tightly closed preventing door rattle.





2180 Turnbuckle Gate Hook and Eye—Designed to draw large doors tight by twisting turnbuckle after door is hooked. Ideal for heavy warehouse, grain bin, or machine shed doors.



832 Barrel Bolt—Extra heavy for use on doors, stock rooms, farm buildings and situations where additional security is desired. Furnished with surface and universal strikes. Can be padlocked. Steel body with rust resistant, zinc-plated finish.

SLIDING DOOR FRAME ACCESSORIES

1266 Pull Center Latch

Pull Center Latch Parts®	
• 6050 #12x1¾ Self Drilling Screws	
• 1266 Center Latch	
• 1266 Pulls	

1266 Pulls require a minimum lateral width of 2-½"

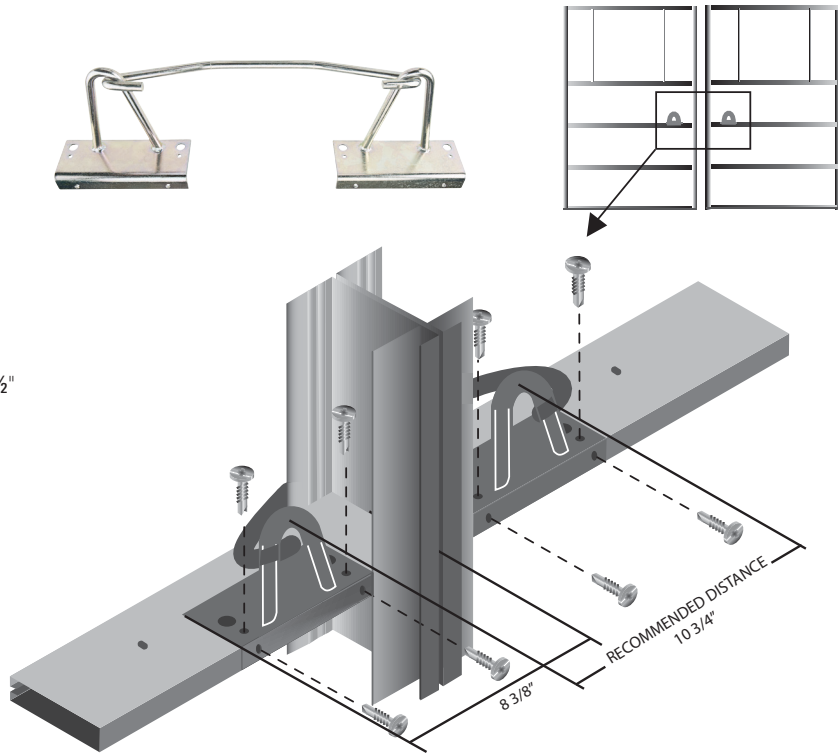

BOX RAIL & ACCESSORIES

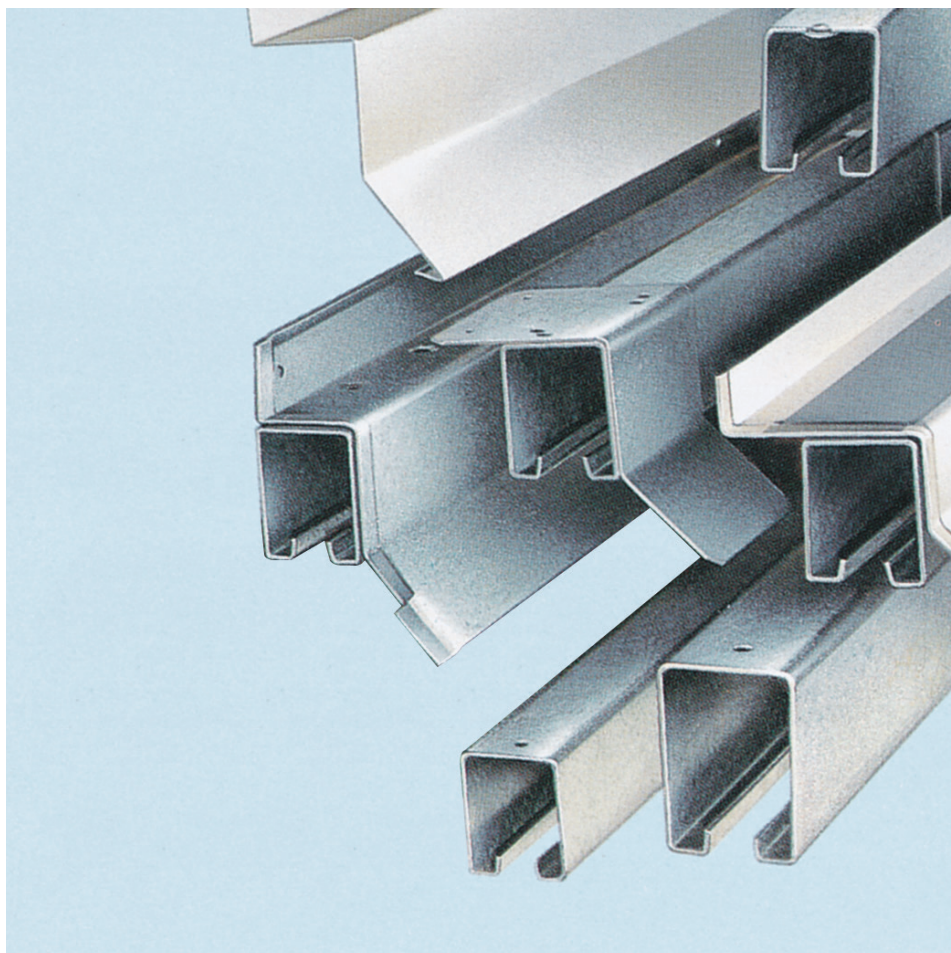

A Complete Selection of Quality Rail

National Hardware has a complete selection of box rails that are designed for use on doors weighing up to 450 lbs (5116) or 600 lbs (5114). Our 450 lbs rated track meets ANSI/BHMA A156.14, Grade 2 specs. Our box rail is manufactured in the USA from galvanized steel for weather resistance and strength and is carefully formed to give an even tread to hanger wheels. National Hardware's box rail comes with optional pre-mounted brackets for fast, simple installations or can be used with many types of single and multiple brackets for a variety of door openings.



BOX RAIL & ACCESSORIES

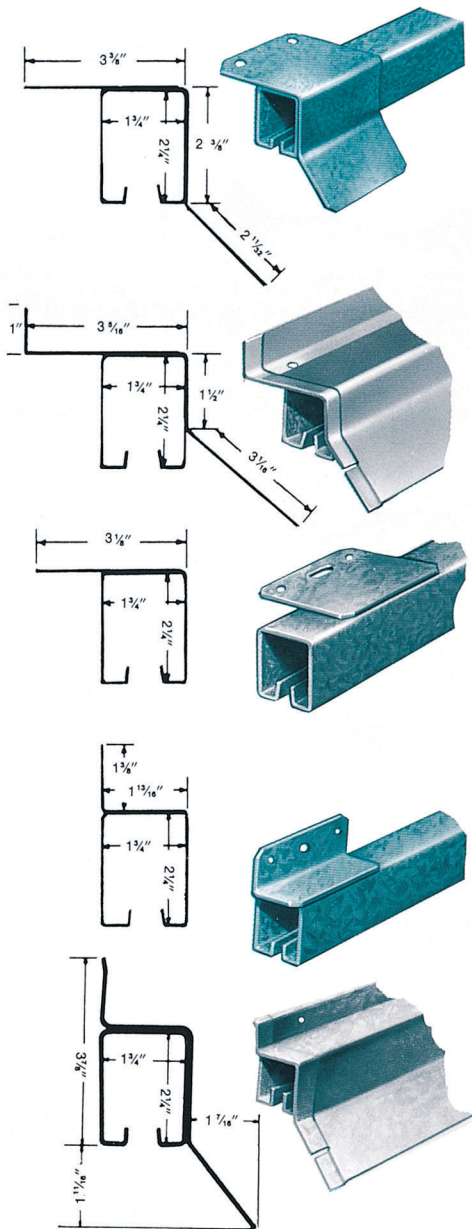

No. 5100 Rail—Top mount. 16 gauge galvanized steel. Mounting/flashing brackets welded to the rail on 2 foot centers. No separate brackets or rail couplings needed. For doors weighing up to 450 lbs. per panel.

No. 5104 White Covered Rail—Top mount. 16 gauge galvanized steel. One piece design features a durable, white pre-finished cover, permanently welded to rail—fast, simple installation without mounting brackets. For doors weighing up to 450 lbs. per panel.

No. 5105 Rail—Top mount. 16 gauge galvanized steel. For interior doors, and exterior doors that travel inside the building and for horse stall doors. Mounting bracket welded to the rail on 2 ft. centers. Just nail the rail to the track board with ring-shank, neoprene washer nails. No separate brackets or rail couplings required. For doors weighing up to 450 lbs. per panel. For use where flashing is not required.

No. 5110 Rail—Face mount. 16 gauge galvanized steel. Welded-on mounting brackets on 2 ft. centers make rail installation fast and easy. Rail is simply attached to building with lag screws. No rail splicing brackets required, as end bracket of each piece of rail overlaps next length for perfect alignment and tight joint. For doors weighing up to 450 lbs. per panel.

No. 59 Covered Rail—Face mount. 16 gauge galvanized steel. A face mounted rail with 18-gauge cover spot-welded on top of rail. No brackets required as cover provides a continuous bracket. For doors weighing up to 450 lbs. per panel.

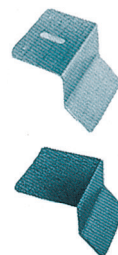

No. 5151 Flashing Bracket—For 5120 flashing. Galvanized steel.

No. 5102B Flashing Bracket—For 3" track board.

BOX RAIL & ACCESSORIES

Applications & Accessories

Face Mount

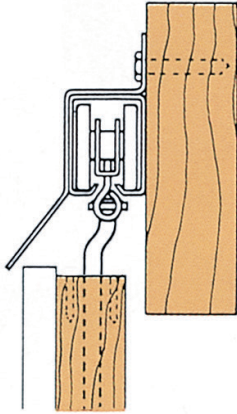

Top Mount

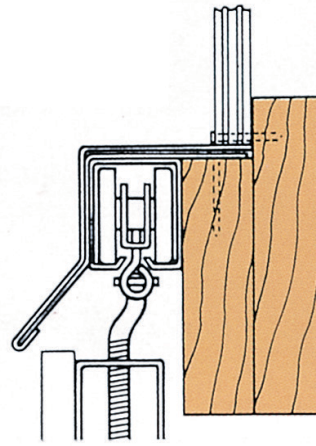

Bracket Mount

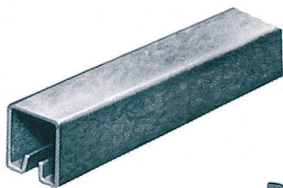
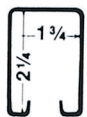
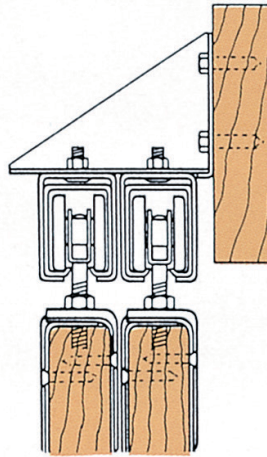

No. 5116 Rail—For doors weighing up to 450 lbs. per panel. 16 gauge galvanized steel rail bundled without fasteners or brackets. Can be used with various types of single and multiple brackets.

No. 5114 Hi-Tensile Steel Rail—Same as 5116, except for doors weighing up to 600 lbs. per panel when used with steel roller bearing hangers.

No. 51ED End Caps—Galvanized steel. For 16 gauge Rail. Used to cap rail end, and also used as center stop using 3/8" x 2" carriage bolt (not incl.).

Brackets (Lag Bolts Included)

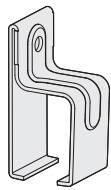

51F
Single

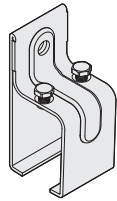

51G
Splice

No. 51F Wall Mount Single Bracket
Used at two foot intervals to hang rail to side of building.

No. 51G Wall Mount Single Joint Splice Bracket
A splice bracket with set screws to join two lengths of rail.

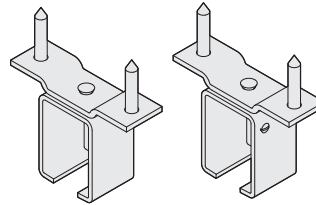

51J

51JS

No. 51J Ceiling Mount Single Bracket

For hanging rail to overhead mounting. Mounting plate swivels for various installations.

No. 51JS Ceiling Mount Single Joint Splice Bracket

For joining two lengths of rail in overhead mounting. Mounting plate swivels for various installations.

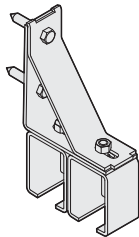

51H

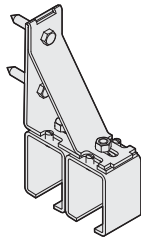

51HS

No. 51H Wall Mount Double Bracket

Adjustable. For by-passing doors. Used at two foot intervals to hang rail to side of building.

No. 51HS Wall Mount Double Joint Splice Bracket

Adjustable. For joining rail sections in a parallel run.

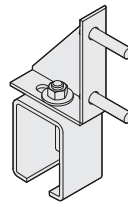

51M

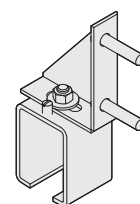

51MS

No. 51M Single Bracket

Adjustable. Used to hang rail to the side of the building. Ideal for use on corrugated siding.

No. 51MS Single Joint Splice Bracket

Adjustable. A splice bracket with set screws to join two lengths of rail in a single run. Ideal for use on metal-sided buildings.

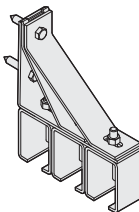

51K

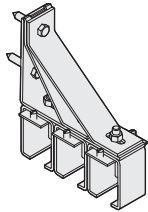

51L2

No. 51K Wall Mount Triple Bracket
Adjustable. For triple by-passing doors. Used at two foot intervals to hang rail to side of building.

No. 51L2 Triangle Only

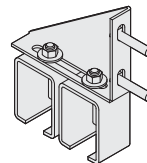

51M-2

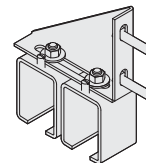

51MS-2

No. 51M-2 Double Bracket

Adjustable. For by-passing doors. Used at 2 ft. intervals to hang rail to side of buildings. Ideal for metal-sided buildings.

No. 51MS-2 Double Splice Bracket

Adjustable. For joining rail sections in a parallel run. Ideal for metal-sided buildings.

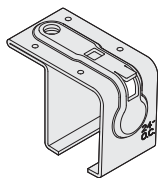

51TMS

No. 51TMS Single Top Mount Splice Bracket

For joining rail selections in a parallel run.

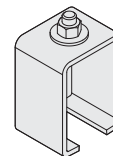

51HB

No. 51HB Box Rail Brackets Only

Replacement brackets for 51H, 51K, 51M and 51M-2 brackets.

For detailed technical information, please visit www.natman.com

BOX HANGERS



Delrin 500CL Bearings are permanently self-lubricating. Our economical Delrin bearing hangers roll easier and last longer than many competitive steel bearing hangers. Requires only 9 lbs of pressure to start rolling door.

Steel Rollers Each axle has 12 hardened and precision ground, alloy steel bearings. Requires only 4 lbs of pressure to start rolling door.

Roll Easier • Last Longer

National Hardware offers Box Rail Hangers with Delrin or steel bearings. Our hangers are designed and manufactured using durable one piece, precision formed steel. National Hardware's Box Rail Hangers have a safe working load of 250 lbs or 300 lbs. We offer hangers in flexible or rigid types with a wide variety of functions.

FLEXIBLE BOX HANGERS

Delrin® 500CL Bearings | Steel Roller Bearings

Offset Bolts

The hangers below are for use on wood frame metal-clad doors using 2 x 4 or 2 x 6 frame. Offset 9" bolt adjusts both vertically and laterally from inside the door. Connecting bolts threaded 7", adjusts laterally 1" by turning offset bolt for desired clearance. Packed with four washers, four hex nuts, two end caps per pair.



No. 5022 Delrin® 500CL Bearings—For use on wood frame doors up to 450 lbs.

No. 5023 Delrin® 500CL Bearings—Same as 5022 except includes 17, 3/8" x 21/2" lag bolts for mounting rail.

No. 5024 Delrin® 500CL Bearings—Same as 5022 except includes two 5151 flashing brackets for 5100 rail.



No. 5062 Steel Roller Bearings—For use on doors up to 600 lbs. when used with Hi-Tensile rails—5103 and 5114.

No. 5064 Steel Roller Bearings—Same as 5062 except includes two 5151 flashing brackets for 5103 rail.

Door Straps



No. 5040 Delrin® 500CL Bearings—Flexible hangers for use on wood frame sliding doors, laterally and vertically adjustable. Packed with two end caps and bolts for attaching door straps. For use on doors up to 450 lbs. 51/4" Strap length.



No. 5047 Delrin® 500CL Bearings—Flexible hangers for use on wood frame sliding doors. Double door strap has opposing holes for bolt mounting. Laterally and vertically adjustable. Hangers are packed with two end caps and bolts for attaching door straps. For use on doors up to 450 lbs. 43/4" Strap length.



No. 5041 Delrin® 500CL Bearings—Flexible hangers for use on wood frame sliding doors. These hangers have vertical and lateral adjustments that can be made from outside the building. Offset bolt is threaded 4" with a lateral adjustment of 1" by turning bolt. For use on doors up to 450 lbs. 51/4" Strap length.

No. 5042 Delrin® 500CL Bearings—Same as 5041 except includes 9, 3/4" x 2" lag screws for rail.



No. 5020 Delrin®—Flexible with drop strap. For use on doors up to 450 lbs when used in pairs with box rail.



No. 5080 Steel Roller Bearings—Flexible hangers for use on wood frame sliding doors, laterally and vertically adjustable. Packed with two end caps and bolts for attaching door straps. For use on doors up to 600 lbs. when used with Hi-Tensile rails—5103 and 5114. 51/4" Strap length.



No. 5087 Steel Roller Bearings—Flexible hanger for use on wood frame sliding doors. Double door strap has opposing holes for bolt mounting. Laterally and vertically adjustable. Hangers are packed with two end caps and bolts for attaching door straps. For use on doors up to 600 lbs. when used with Hi-Tensile rails—5103 and 5114. 43/4" Strap length.

RIGID BOX HANGERS

Delrin® 500CL Bearings | Steel Roller Bearings

Trucks



No. 5000 Delrin® 500CL Bearings—Truck only. Durable one piece, precision formed steel. For use with all rail. For doors up to 450 lbs.



No. 5050 Steel Roller Bearings—Truck only. Durable one piece, precision formed steel. For use on doors up to 600 lbs. when used with Hi-Tensile rails—5103 and 5114.

Straight Bolts



No. 5001 Delrin® 500CL Bearings—Includes truck, connecting bolt and nuts. For use on doors up to 450 lbs. Bolt lengths available; 31/8", 4-1/2", 5", 5-1/2" and 6."



No. 5051 Steel Roller Bearings—Includes truck, connecting bolt and nuts. For use on doors up to 600 lbs. when used with Hi-Tensile rails—5103 and 5114. Bolt lengths available; 31/8", 41/2", 5", 51/2" and 6".

Offset Bolts



No. 5002 Delrin® 500CL Bearings—For use on wood lateral doors. These rigid hangers have both vertical and lateral adjustments that can be made from inside the building after installation. Bolt threaded 4", adjusts laterally 11/2" by turning offset bolt for desired clearance. Included are two washers and two hex nuts for each bolt. Bolt sizes 81/2" or 101/2". For use on doors up to 450 lbs.



No. 5005 Delrin® 500CL Bearings—For use on wood frame sliding doors, laterally and vertically adjustable. Hangers are packed with two end caps and bolts for attaching door strap. Door strap is 51/4" long. For use on doors up to 450 lbs.



No. 5055 Steel Roller Bearings—For use on wood frame sliding doors, laterally and vertically adjustable. Hangers are packed with two end caps and bolts for attaching door strap. Door strap is 51/4" long. For use on doors up to 600 lbs. when used with Hi-Tensile rails—5103 and 5114.

No. 5005B Delrin® 500CL Bearings—Same as No. 5005 except includes two 51F and one 51G rail brackets.



No. 5008 Delrin® 500CL Bearings—Double strap hanger for use on wood framed by-passing sliding doors. Holes are staggered for screw mounting. Packed with screws and two end caps. Door strap is 43/4" long. For use on doors up to 450 lbs.



No. 5009 Delrin® 500CL Bearings—For round-the-corner or heavy folding door installations. Adjustable ball bearing swivels on hanger to assure smooth, easy operation. Packed with mounting bolts and two end caps. Door strap is 63/4" long. For use on doors up to 450 lbs.

TRACKMASTER® ROUND RAIL & ACCESSORIES

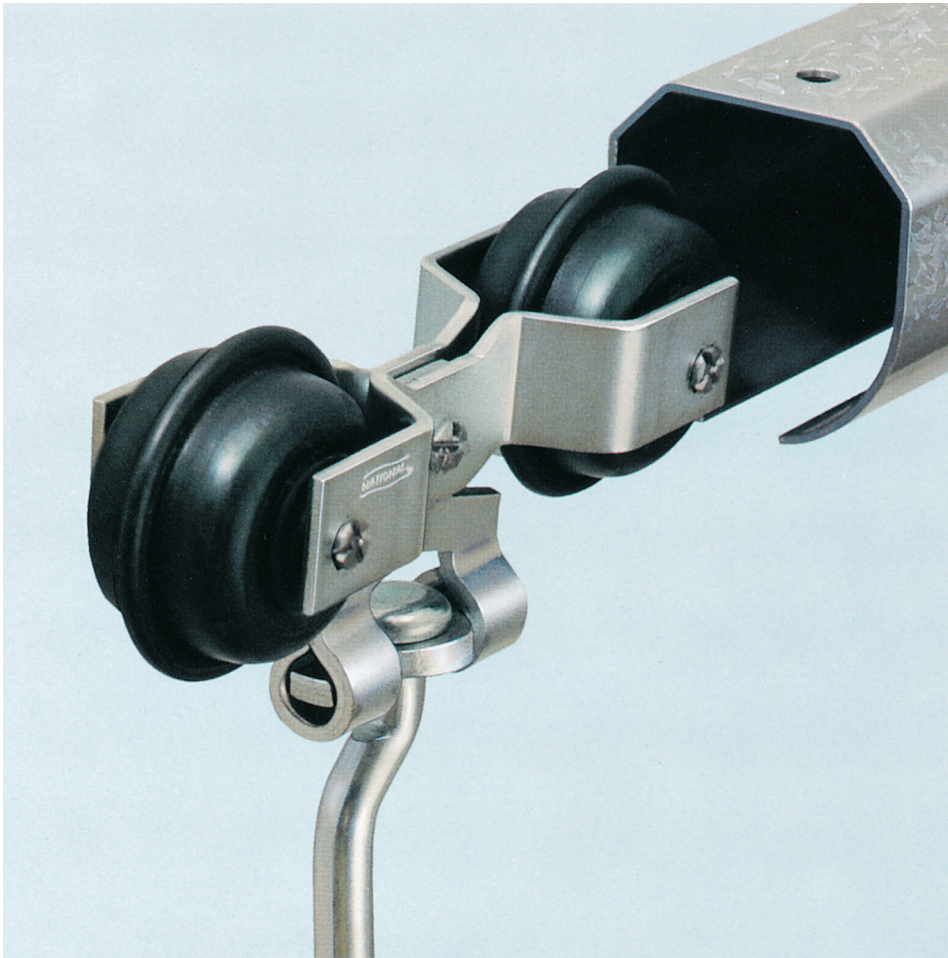

Round Rail & Round Hangers

TRACKMASTER®

National Hardware's Trackmaster round rail and hangers are advanced design with flat top and sides for easier mounting and better stability. Designed for doors weighing up to 600 lbs. Trackmaster allows track to be self cleaning and smoother operation. Manufactured in the USA from galvanized steel for weather resistances and strength.



TRACKMASTER® ROUND RAIL & ACCESSORIES

TRACKMASTER®

Benefits

TrackMaster rail and hangers combine the easy mounting features and stability of box-rail with the smooth operation of round. The result is a round-rail system that is easier-to-install, easier-to-operate, self-cleaning, and longer-lasting. Supporting a 600 lb. door, TrackMaster hangers have been torture tested without failure through over 10,000 cycles of opening and closing a door! (That's opening and closing the door once a day for 30 years!)

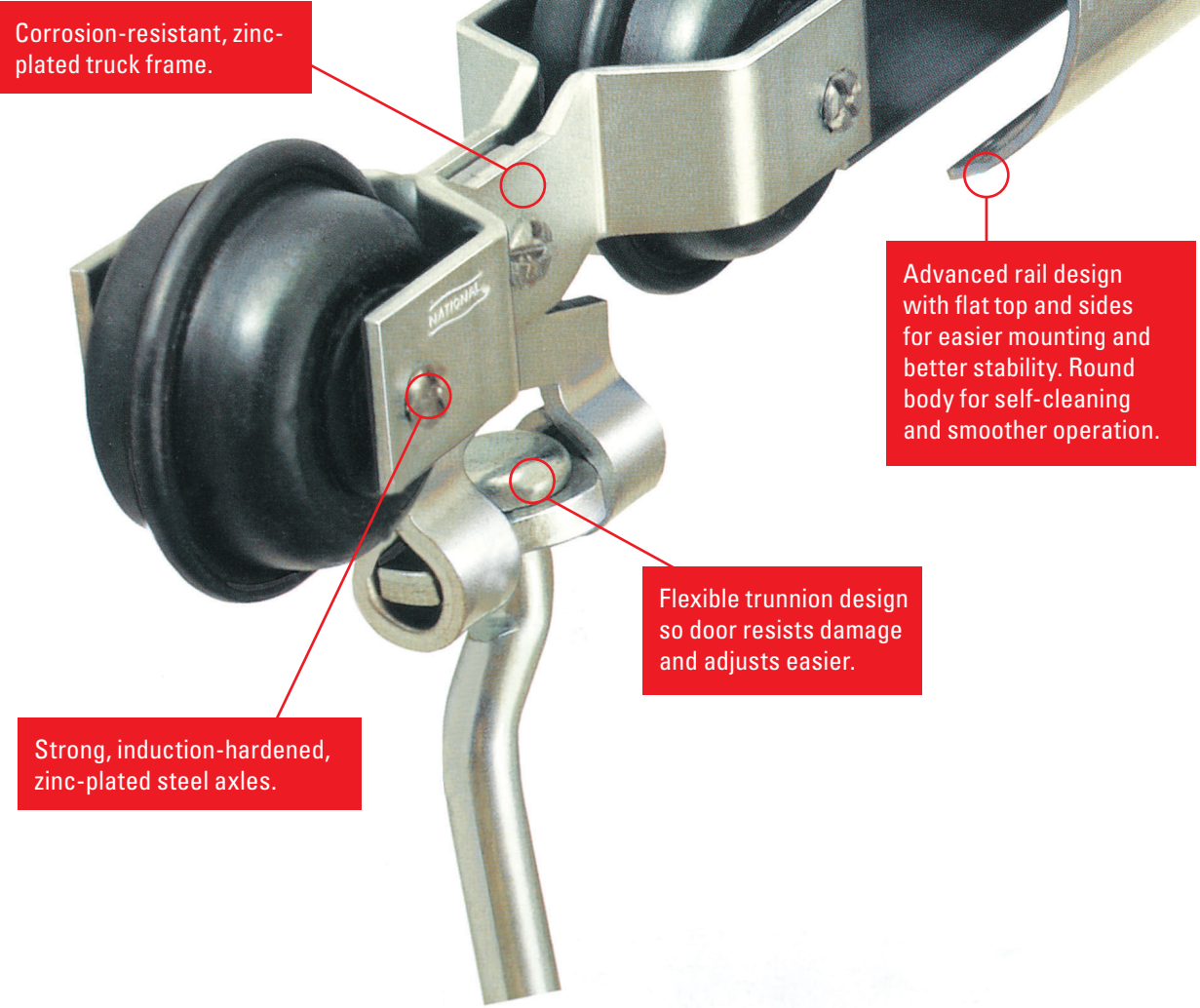

Corrosion-resistant, zinc-plated truck frame.

Strong, induction-hardened, zinc-plated steel axles.

Flexible trunnion design so door resists damage and adjusts easier.

Advanced rail design with flat top and sides for easier mounting and better stability. Round body for self-cleaning and smoother operation.

TRACKMASTER® ROUND RAIL & ACCESSORIES

TrackMaster™ is interchangeable with other brands of round rail and hangers.

TrackMaster™ Hangers can be used with Cannonball® and Combo® brand* rail—and vice versa. So, when you add National Trackmaster Round, you can supply replacement components to current customers.

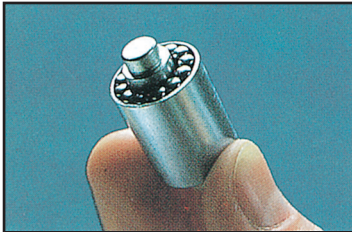

Precision ground and hardened steel roller bearings for longer, smoother operation.

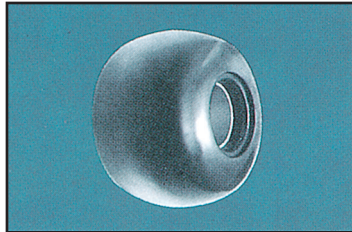

Quiet, smooth rolling Delrin® wheels have steel roller bearings and hold up to a 600 lb. door per pair.

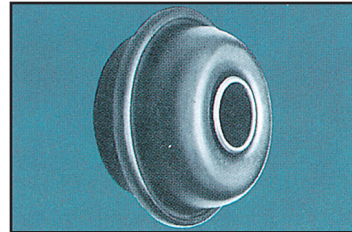

Hardened steel wheels with steel roller bearings hold up to a 600 lb. door.

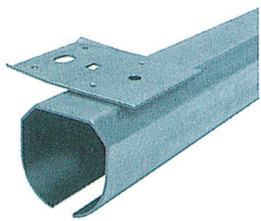

Galvanized Steel Round Rail

- Easier mounting and alignment with flat top and sides.
- Self-cleaning and self-aligning round body.

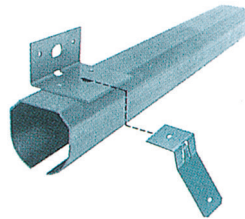

Unique Snap-On Flashing Bracket for 1 1/2" or 3 1/2" Thick Doors

- Simplifies rail installation. Just attach rail into track board and "snap-on" flashing brackets—then add flashing.

All new brackets can be used with a snap-on flashing bracket



TrackMaster "Round" Checklist

Rail

5400	Plain Rail (8' – 12')
5430	Face Mount Rail (8' – 12')
5433	Top Mount Rail (8')

Door Frames

Easy Frame® Verticals (Steel & Wood) 6060, 6059 Max Easy Frame® (Aluminum)

Accessory Hardware

Pulls, Stops, Latches, etc.

Hangers

Delrin® Wheels, Flexible Trunnion, Steel Roller Bearings

5301	Straight Bolt 3-1/8" or 4 1/2"
5302	Offset Bolt (Wood Door)
5330	Door Strap

Hardened Steel Wheels, Flexible Trunnion, Steel Roller Bearings

5351	Straight Bolt 3-1/8" or 4 1/2"
5352	Offset Bolt (Wood Door)
5380	Door Strap

Flashing & Flashing Brackets

5436	Snap-On Flashing Bracket (1 1/2" Door)
5437	Snap-On Flashing Bracket (3 1/2" Door)

Rail/Mounting Brackets

5405	Splice Collar
5408	Rail End Cap
5412	Adj. Single Bracket
5414	Adj. Double Bracket
5415	Adj. Double Splice Bracket
5418	Rail Bracket Only
5419	Splice Bracket Only

*Cannonball® and Combo® are registered trademarks of Cannonball Industries, Inc. and Combo Corp.

TRACKMASTER® ROUND RAIL ACCESSORIES

TrackMaster® Round Rail

No. 5400 Plain Rail —

Separate face-mount brackets.
For doors weighing up to 600 lbs. per panel. Fourteen gauge galvanized steel bundled without fasteners or brackets.
For use with various types of single and multiple brackets. In 8' to 12' lengths.

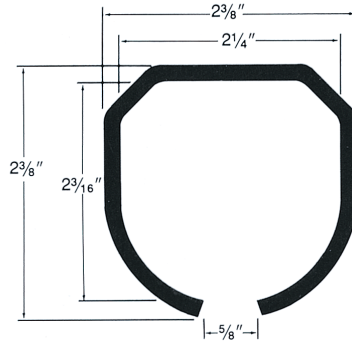

Rail Brackets (Lag Bolts Included)

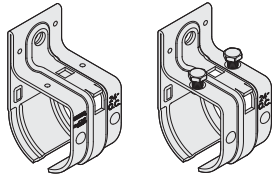

5420

5421

No. 5420 Single Bracket

Wall mount. Used at two-foot intervals to bring rail to side of building. 10 each

No. 5421 Single Splice Bracket

Wall mount. A splice bracket with set screws to join and hold two lengths of rail together. 5 each

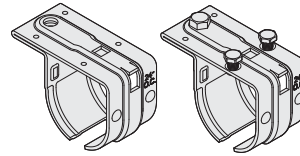

5422

5423

No. 5422 Single Bracket-Top Mount

Top Mount design so brackets can be installed on a 2 x 6 header board. Used at 2ft intervals. 10 each

No. 5423 Single Round Splice Bracket-Top Mount

Top mount splice bracket with set screws to join and hold two lengths of rail together. 5 each

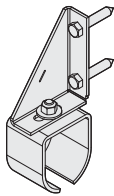

5412

No. 5412 Adjustable Single Bracket

Wall mount. Used at two-foot intervals to hang rail to side of building. Ideal for use on corrugated siding due to narrow surface. 10 each

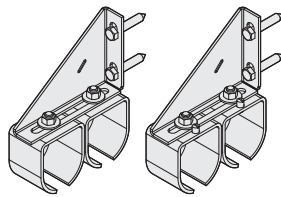

5414

5415

No. 5414 Adjustable Double Bracket

Wall mount. Used at two-foot intervals to bring double runs of rail to side of building for by-pass installation. Ideal for use on corrugated siding due to narrow surface. 10 each

No. 5415 Adjustable Double Splice Bracket

Wall mount. A splice bracket with set screws to join and hold two double lengths of rail together. 2 each

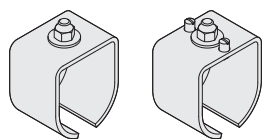

5418

5419

No. 5418 Rail Bracket Only (No lag bolts)

Packed with bolt, nut and washer. 50 each

No. 5419 Rail Splice Bracket Only (No lag bolts)

Packed with bolt, nut and washer. 10 each

TrackMaster® Rail Applications

By-Pass Installation

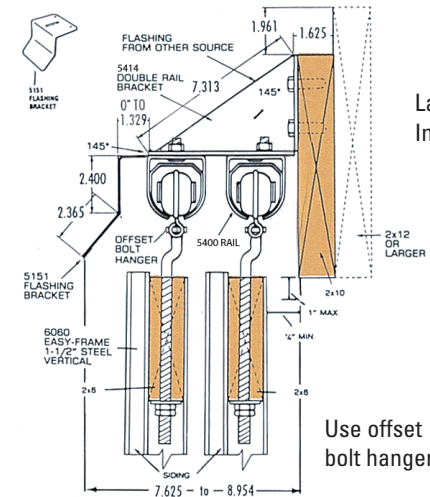

Lag Bolts Included

Use offset bolt hanger

FACE MOUNT

TOP MOUNT

BRACKET MOUNT

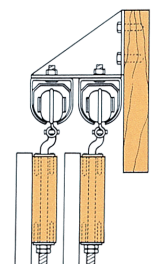
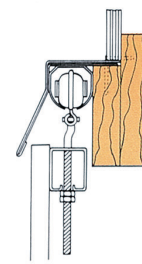
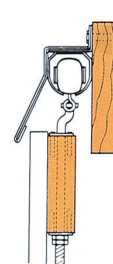

TRACKMASTER® ROUND RAIL & ACCESSORIES

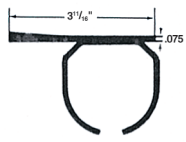

No. 5433 Top Mount Rail

Welded-on top mount brackets (2 foot O.C.). For doors weighing up to 600 lbs. per panel. Fourteen gauge galvanized steel. Welded on mounting brackets for fast, easy installation. Just nail the rail to track board. If flashing is required, use our #5436, 5437 Snap-On Flashing Brackets. Rail in 8' lengths.

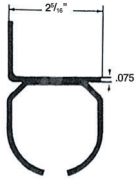

No. 5430 Face Mount Rail

Welded-on face mount brackets (2 foot O.C.). For doors weighing up to 600 lbs. per panel. Fourteen gauge galvanized steel. Welded on mounting brackets for fast, easy installation. If flashing is required, use our Snap-On Flashing Brackets #5436 or 5437. Rail in 8' to 12' lengths.

Unique Snap-On Flashing Bracket For 1 1/2" or 3 1/2" thick doors.

Simplifies rail installation. Just attach rail to track board and "snap-on" flashing brackets—then add flashing.

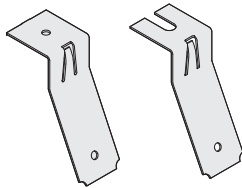

5436
.075 Material
Thickness

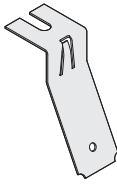

5436
.075 Material
Thickness

No. 5436 1 1/2" Door Snap-On Flashing Bracket
Snaps-On 5430/5433 rails.
Galvanized steel. 50 each.

No. 5436 1 1/2" Door Snap-On Flashing Bracket - Custom Slot
Custom slot in the top of the bracket allows for installation with rail brackets bolted to a triangle or strap support. For use with 5412 & 5415 rail brackets. 50 each.

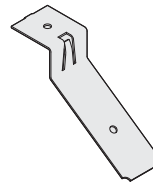

5437
.075 Material
Thickness

No. 5437 3 1/2" Door Snap-On Flashing Bracket
Snaps-On 5430/5433 rails.
Flashing from alternate source.
Galvanized steel. 50 each.

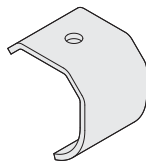

5405

No. 5405 Splice Collar

Unique design supports the end of two rails while not interfering with flat mounting surface of rail. No fasteners required. Simply slide onto rail while installing. Use with #5430, 5433 and 5460 rails. 10 each.



5408

No. 5408 Rail End Cap

(No lag bolts.) Packed with bolt, nut and washer.

TRACKMASTER® ROUND RAIL & ACCESSORIES

Flexible Hangers with Hardened Steel Wheels

Hardened steel wheel hangers for doors weighing up to 600 lbs. All National TrackMaster™ hangers have corrosion-resistant, zinc-plated strong steel trucks and induction-hardened zinc-plated steel axles for longer life. Plus steel roller bearings of precision-ground hardened steel with sealed bearing chamber and advanced-design seal. This results in a longer lasting, easier rolling door system.



No. 5350 Round Rail Trucks
Steel wheels. Flexible trunnion
Precision-ground and hardened steel
roller bearings, axles and sleeves
provide longer life and easier operation.



No. 5351 Straight Bolt Hanger
Steel wheels. Flexible trunnion straight
bolt with nuts 5" bolt lengths.
Capacity 600 lbs./pr.



No. 5352 Offset Bolt Hanger
Steel wheels. Flexible trunnion. For wood frame metal-
clad doors using a 2 x 6 top lateral. Offset 9" bolt (with 7"
thread) adjusts door vertically (7") and laterally (1") from
inside the building. Packed with four washers and four hex
nuts. Capacity 600 lbs./pr.



No. 5380 Door Strap Hanger
Steel wheels. Flexible trunnion hanger for use on wood frame
sliding doors, laterally and vertically adjustable. Packed with
bolts for attaching door straps. Capacity 600 lbs./pr.

TRACKMASTER® ROUND RAIL & ACCESSORIES

Flexible Hangers with Delrin® Wheels



5300 Round Rail Trucks

Delrin wheels. Flexible trunnion. Precision-ground and hardened steel roller bearings, axles and sleeves provide longer life and easier operation.



No. 5301 Straight Bolt Hanger

Delrin® wheels. Flexible trunnion straight bolt with nuts 5" bolt lengths. Capacity 600 lbs./pr.



No. 5302 Offset Bolt Hanger

Delrin® wheels. Flexible trunnion. For wood frame metal clad doors using a 2 x 6 top lateral. Offset 9" bolt (with 7" thread) adjusts door vertically (7") and laterally (1") from inside the building. Packed with four washers and four hex nuts. Capacity 600 lbs.



No. 5330 Door Strap Hanger

Delrin® wheels. Flexible trunnion hanger for use on wood frame sliding doors. Laterally and vertically adjustable. Packed with bolts for attaching door straps. Capacity 600 lbs./pr.

Durable Delrin® wheel hangers with steel bearings are strong, quiet and easy rolling. All National TrackMaster hangers have corrosion-resistant, zinc-plated strong steel trucks and induction-hardened, zinc-plated steel axles for longer life. Bearings of precision-ground hardened steel with sealed bearing chambers and advanced design seal for easy, quiet rolling. Capacity 600 lbs./pr.

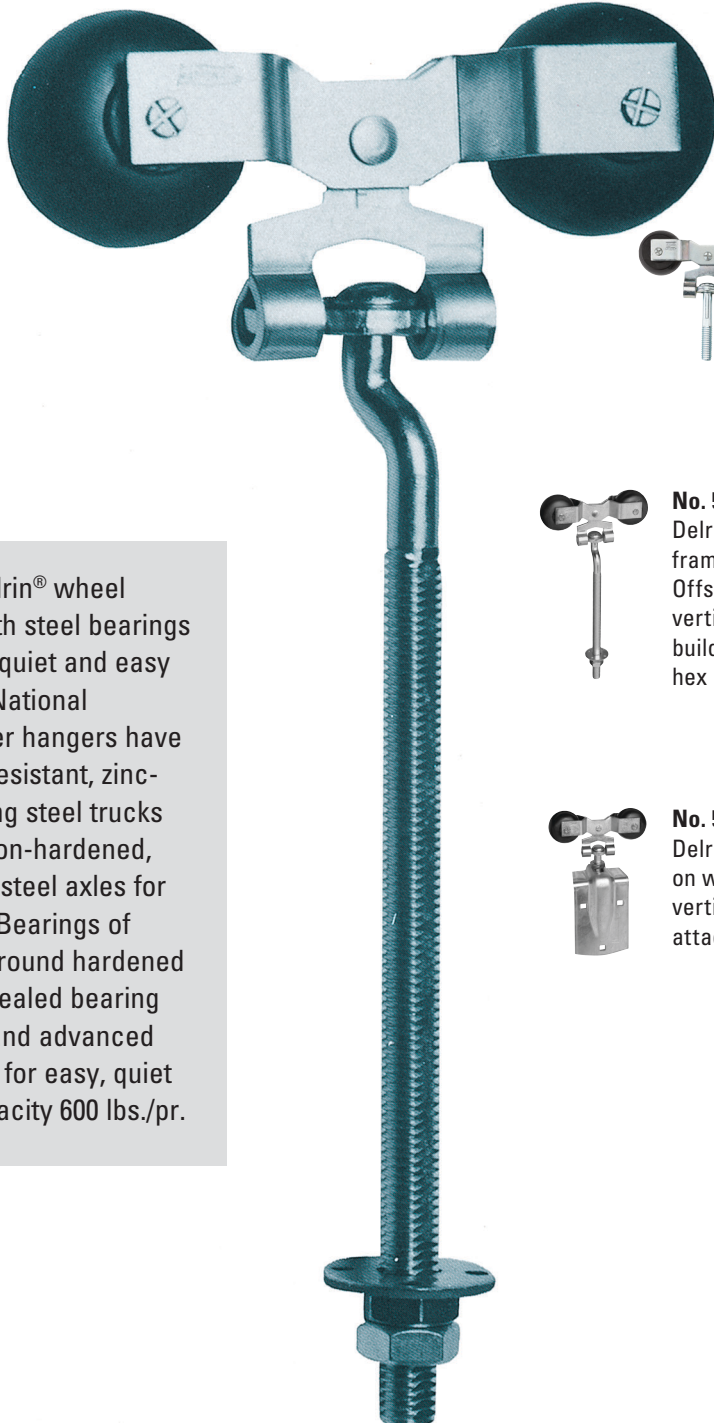

NOTES

